

AEROCOMM Co., Ltd.

MICROWAVE DEVICES DIVISION

704-860 MHz

Mechanical Outline : DROP IN CIRCULATOR

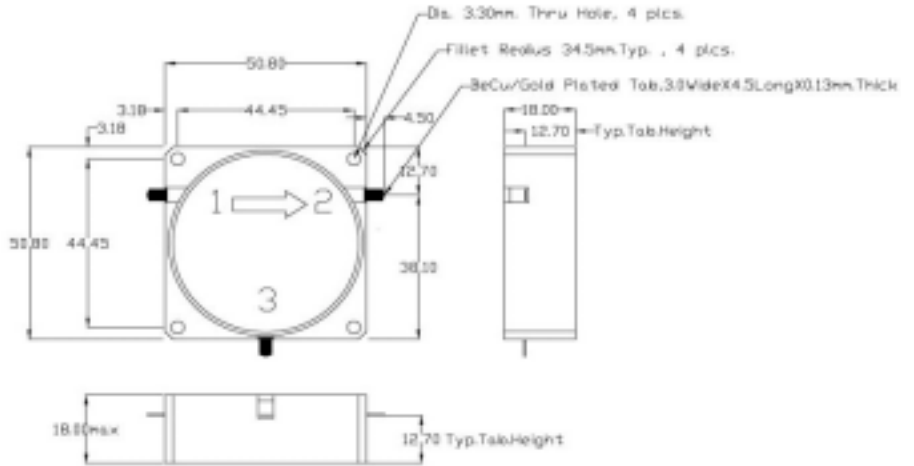

Specification :	Frequency	Isolation	Ins. Loss	VSWR	Fwd. Power	Size (mm.)
Model No:	GHz	dB (min)	dB (max)	(max)	Avg. (watts)	W x L x T
DC1-C704.860-OPT.01-A1-(T9T9T9)	0.704 -0. 860	20	0.3	1.25	700	50.8x50.8x18.0

Application :

Electrical Performances (Typical Values) :

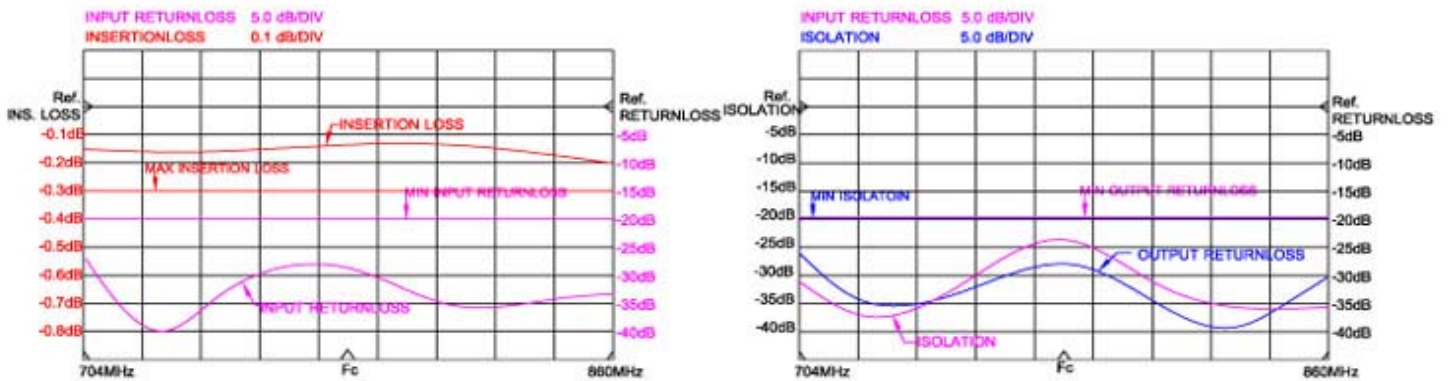

Specifications are subject to change without prior notice.

89-89/1 Soi Intramara 41, Sutthisarn Road, Dindang, Bangkok 10400 Thailand

Phone : (662) 6938300-2, (662) 6937880-1, Fax. (662) 6938304

Email : aerocomm@aerocommthailand.com Website : <http://www.aerocommthailand.com>