



T50-6G-30T1-00

Flange Termination 30 Watts, 50 Ω

Electrical Specs

Resistance Value (Ω) :	50, $\pm 2\%$
Frequency range (MHz) :	DC-6000
Power (Watts) :	30
VSWR :	1.25 : 1

Mechanical Specs

Flange Style :	1 Hole
Flange Size WxLxT (mm.) :	6.0 x 13.0 x 1.5
Tab width/Thickness (mm.) :	1.0/0.150
Tab Height (mm.) :	2.5
Mounting Hole Dia.(mm.) :	3.2



Environment & Others

Operating Temp. :	-55°C to + 150°C
Resistive Element :	Thick film
Substrate :	BeO
Cover :	Al ₂ O ₃
Lead :	Silver or Copper

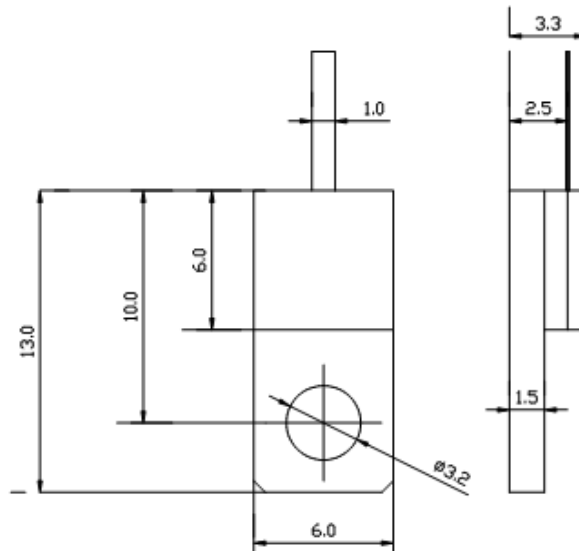

unit : mm.

AEROCOMM Co., Ltd.

89 & 89/1 Intamara 41, Sutthisarn Road , Dindaeng , Bangkok 10400 THAILAND

Tel : (662) 6938300 - 2, (662) 6937880 - 1 Fax : (662) 6938304

Email : aerocomm@aerocommthailand.com Website : www.aerocommthailand.com

Specifications contained herein are subject to change without notice. AeroComm Co., Ltd. assumes no liability for the use of this information.